

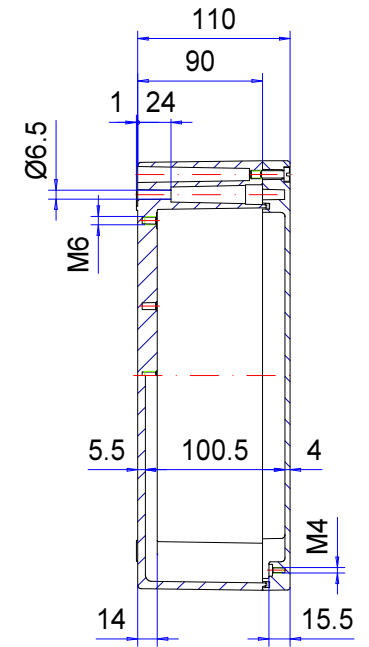

Enclosure series aluKOM

Type: AK 311

Material-No.: 106.311.000

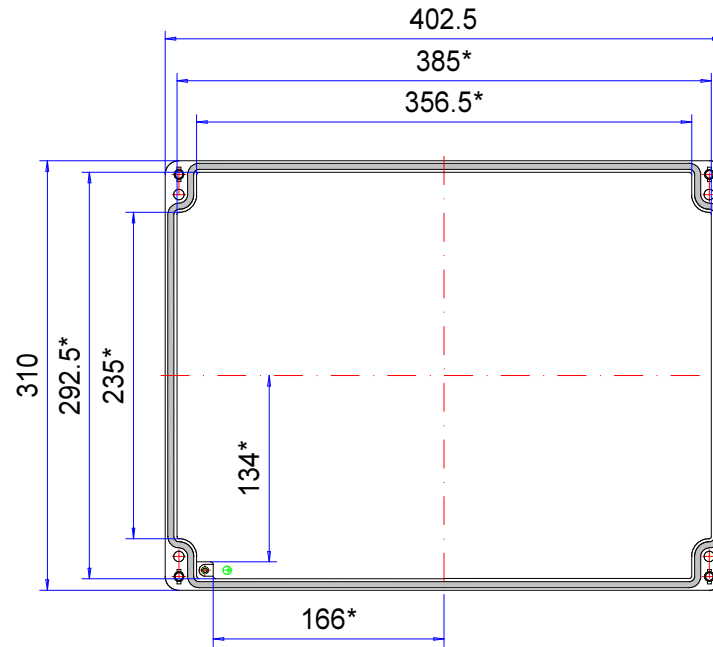
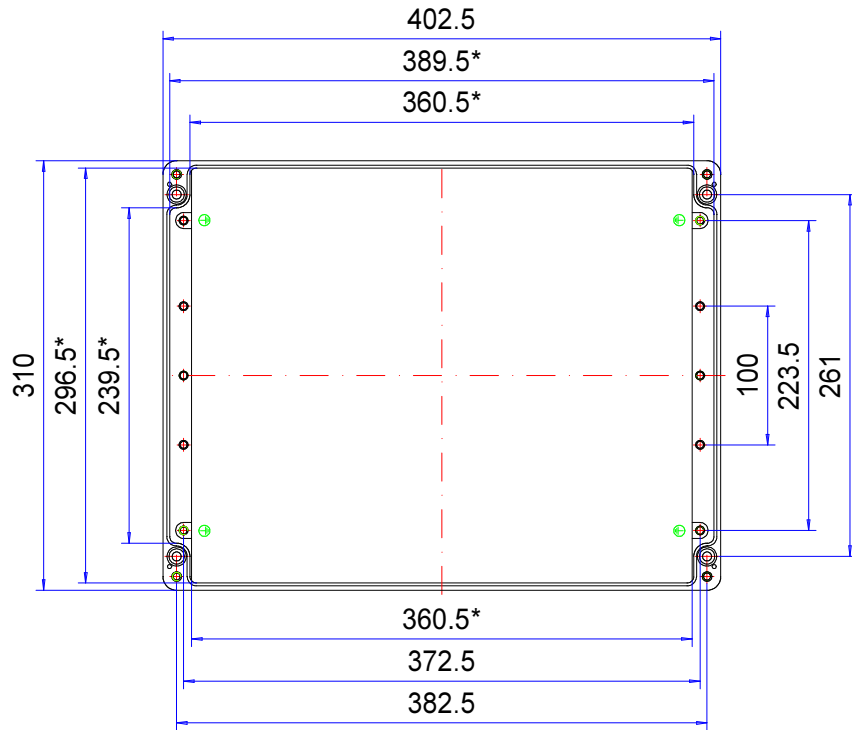

* Please note: Mould slope for casting ejection, dimensions in the amount of the bottom!

Enclosure material	GD-AI Si 12 (DIN 1725)		Weight	6.300 g
Lid screws	4x stainless steel 1.4567 (V2A), captive		Earthing screws	4x M6x8, copper-plated
Gasket	Dosed, PUR		Coating	Powder coating RAL 7032, pebble grey
Ingress protection	IP66 EN 60529		Tolerance	GTA 13/5 DIN 1688-4 (outside dimensions ±0,5mm)

106.311.000
aluKOM AK 311



Product overview

Material	Aluminium
Protection Class	IP 66/EN 60529
Color	RAL 7032
Certifications	GOST
Length (L)	403 mm
Width (W)	310 mm
Height (H)	110 mm
Weight (g)	6300 g

aluKOM

THE CLASSIC STANDARD TERMINAL ENCLOSURE

IP 66

The key product features:

- Enclosure material: diecast aluminium
- Enclosure surface: powder coating, RAL 7032
- Compatible with standard enclosures available on the market, therefore easy to exchange
- Lid screws in stainless steel 1.4567
- Enclosure seal: TPE moulded gasket, PUR

aluKOM is a watertight IP66 enclosure made from diecast aluminium which has gone on to become the global standard since its introduction. Originally developed as a terminal enclosure, it is ideal for mounting all types of electronic and electrical components.

The large range of sizes is suitable for many different applications. aluKOM is also available with an EMC gasket. Threaded screw bosses are provided in the base for fitting circuit boards, terminal rails, mounting plates etc. Compatible cable glands and accessories are also available.

We can supply aluKOM enclosures fully customised to your requirements.

Enclosure sizes

24

Additional info

Compatible with available standard products

Wide variety of accessories

Optional: EMC model also available

Enclosure

Die-cast aluminium

EN AC 44300/EN AC-44200 (DIN EN 1706)

1° mould slope for casting ejection > internal circumference dimensions decrease by 1° towards enclosure bottom.

Fastening

Separate screw channels, fastening brackets available as accessories

Internal mounting

M4/M6 fastening thread in lateral bars on the enclosure base

Ingress protection

IP 66 / EN 60529

Gasket

Chloroprene O-ring gasket (CR)

or: TPE moulded gasket, silicone-free

Optional: Silicone gasket

Lid screws

Stainless steel 1.4567, captive

Surface

Powder coating, pebble grey RAL 7032

Optional: Special colours

Optional: Corrosion protection

Customising

Learn more about our [full customising service for installation-ready enclosures](#)

Full-Service-Products

Customization according to your wishes.



Our passion is enclosures.



Expert advice

Everything begins with individual advice. We'll be pleased to support you with your project and find solutions for every requirement. Customer-specific solutions are our speciality.



Sample service

Test our products with your internal mounting. We'll be pleased to send you a sample enclosure for inspection with no strings attached.



Drilling

We'll manufacture every enclosure for you according to your exact specifications – whether they involve precise drilling or large tolerance.



Milling

Thanks to our modern CNC production, we can quickly and efficiently mill custom-fit cut-outs and contours to match your exact specifications.



Engraving

Our services also include engraving your logo and other elements, which we can of course perform in any colour you desire.



Lasering

We can process stainless steel enclosures and plates quickly and reliably according to your individual requirements thanks to our in-house lasering centre.



Powder coating

We can powder coat enclosures, command enclosures and suspension systems in any RAL colour you desire. Custom colours are of course also possible.



Painting

We can also paint all our enclosures in any RAL colour you desire. The application of primer and special colour structures are possible, as well.



Serigraphy

If desired, we can apply your logo and lettering or other markings using serigraph printing.



Digital printing

Digital printing is particularly worthwhile for low-volume orders and for realising complex patterns or images.



EMC enclosures

We offer our conFORM low-price standard EMC enclosure to protect your internal mounting against electromagnetic radiation. On request, we can also supply an EMC-compliant version of any other ROLEC enclosure.



Displays

We are able to offer the right made-to-measure display for all our enclosures – in varying sizes and degrees of robustness depending on the application.



Accessories

ROLEC's portfolio also includes matching front plates, mounting plate, supporting rails and terminal blocks as well as a range of cable glands, blanking plugs etc.



Assembly

Would you like to have all your components supplied already assembled? No problem. Our assembly team will be pleased to perform all assembly work on your behalf.



Our Service

If you have any requirements for services not listed here, please ask us. Customer-specific solutions are our speciality. We also are keen to take on unusual tasks.

We will help you with those challenges that many others would give up on.