

# Enclosure series polyDOOR

Type: PD 200

Material-No.: 130.200.000

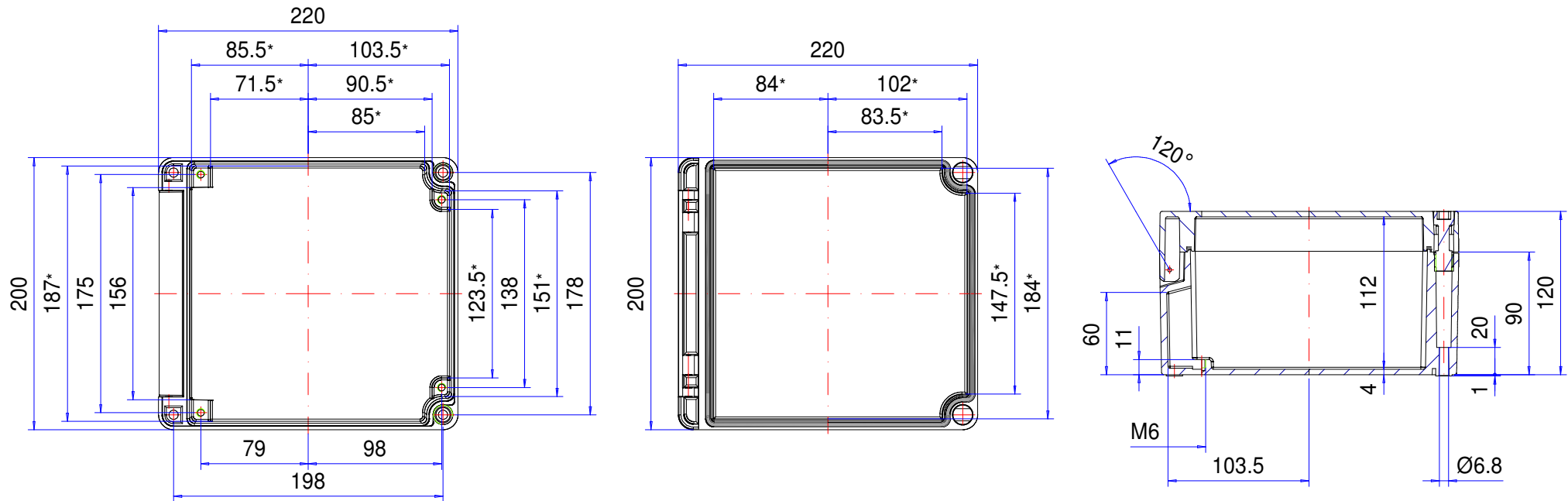

\* Please note: Mould slope for casting ejection, dimensions in the amount of the bottom!

Enclosure material	Polyester GrP, UL 94 V-0, RAL 7032, pebble grey		Ingress protection	IP66 EN 60529
Lid screws	2x Polyamide (PA), captive		Weight	1.800 g
Gasket	1x Chloroprene (CR), light grey		Tolerance	DIN ISO 16901 T-130 (outside dimensions ±0,5mm)

**130.200.000**  
**polyDOOR PD 200**



**Product overview**

Material	Polyester
Protection Class	IP 66/EN 60529
Color	RAL 7032
Certifications	CSA (optional), UL (optional), GOST
Length (L)	220 mm
Width (W)	200 mm
Height (H)	120 mm
Weight (g)	1800 g

## **polyDOOR**

### THE ROBUST, HINGED POLYESTER ENCLOSURE

#### **IP 66**

##### **The key product features:**

- Enclosure material: glass-fibre reinforced polyester
- Enclosure surface: similar to RAL 7032
- Integrated hinges
- Integrated viewing panel
- Lid screws in polyamide
- Flammability: UL-94 V-0
- Enclosure seal: O-ring gasket (EPDM)

---

polyDOOR is a range of weather-resistant IP 66 enclosures in glass-fibre reinforced polyester that features a hinged front lid for easy access. The enclosures are ideal for industrial electronics and control equipment used in harsh indoor and outdoor applications.

Special features include integrated hinges for opening the lid, transparent front windows and optional lid fixings: slotted (standard), triangular or square head for tamper protection, and hand screws for fast access. Threaded fixing pillars are provided inside for mounting the components. polyDOOR is available in a wide range of standard sizes. Cable glands and other accessories such as terminal rails and mounting plates are also available.

We can supply polyDOOR enclosures fully customised to your requirements.

#### **Enclosure sizes**

8

#### **Further information**

Corrosion-resistant lid fastening thread made from stainless steel

Various locking screws available

Application-specific accessories available

Full protective insulation in accordance with VDE 0100

#### **Enclosure**

Polyester glass fibre reinforced, halogen-free

similar to RAL 7032, pebble grey, surface resistance < 10<sup>9</sup> Ohm

Optional: similar to RAL 9005, deep black, surface resistance < 10<sup>9</sup> Ohm

1° mould slope for casting ejection > internal circumference dimensions decrease by 1° towards enclosure bottom.

#### **Flammability**

UL 94 V-0, self-extinguishing

### **Fastening**

Single-channel lid and assembly fastening outside of the enclosure interior

Optional: External mounting brackets made from stainless steel

### **Internal mounting**

M6 fastening thread on the enclosure floor

### **Ingress protection**

IP 66 / EN 60529

### **Gasket**

EPDM O-ring gasket

Optional: Silicone gasket

### **Lid screws**

Polyamide, corrosion-resistant and captive, slotted design

Optional lid screws: triangular, square and hand screw

### **Customising**

Learn more about our [full customising service for installation-ready enclosures](#)

# Full-Service-Products

Customization according to your wishes.



Our passion is enclosures.



Expert advice

Everything begins with individual advice. We'll be pleased to support you with your project and find solutions for every requirement. Customer-specific solutions are our speciality.



Sample service

Test our products with your internal mounting. We'll be pleased to send you a sample enclosure for inspection with no strings attached.



Drilling

We'll manufacture every enclosure for you according to your exact specifications – whether they involve precise drilling or large tolerance.



Milling

Thanks to our modern CNC production, we can quickly and efficiently mill custom-fit cut-outs and contours to match your exact specifications.



Engraving

Our services also include engraving your logo and other elements, which we can of course perform in any colour you desire.



Lasering

We can process stainless steel enclosures and plates quickly and reliably according to your individual requirements thanks to our in-house lasering centre.



Powder coating

We can powder coat enclosures, command enclosures and suspension systems in any RAL colour you desire. Custom colours are of course also possible.



Painting

We can also paint all our enclosures in any RAL colour you desire. The application of primer and special colour structures are possible, as well.



Serigraphy

If desired, we can apply your logo and lettering or other markings using serigraph printing.



Digital printing

Digital printing is particularly worthwhile for low-volume orders and for realising complex patterns or images.



EMC enclosures

We offer our conFORM low-price standard EMC enclosure to protect your internal mounting against electromagnetic radiation. On request, we can also supply an EMC-compliant version of any other ROLEC enclosure.



Displays

We are able to offer the right made-to-measure display for all our enclosures – in varying sizes and degrees of robustness depending on the application.



Accessories

ROLEC's portfolio also includes matching front plates, mounting plate, supporting rails and terminal blocks as well as a range of cable glands, blanking plugs etc.



Assembly

Would you like to have all your components supplied already assembled? No problem. Our assembly team will be pleased to perform all assembly work on your behalf.

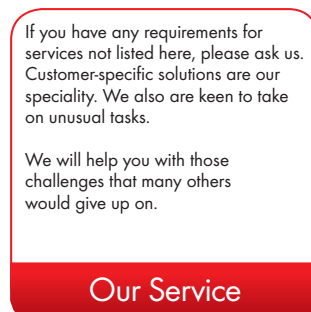

Our Service

If you have any requirements for services not listed here, please ask us. Customer-specific solutions are our speciality. We also are keen to take on unusual tasks.

We will help you with those challenges that many others would give up on.