

Enclosure series polyKOM

Type: PK 162

Material-No.: 180.162.000

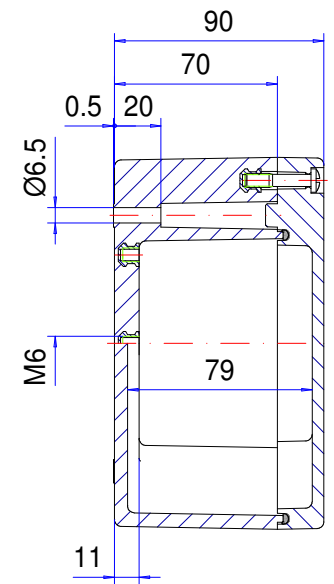
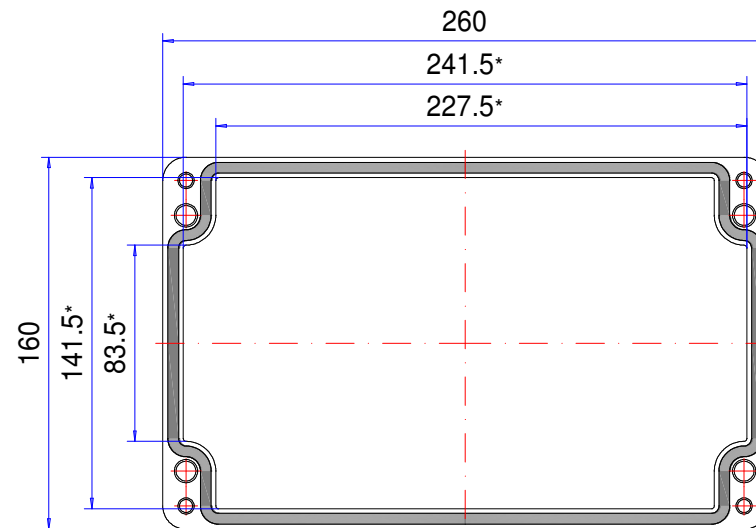
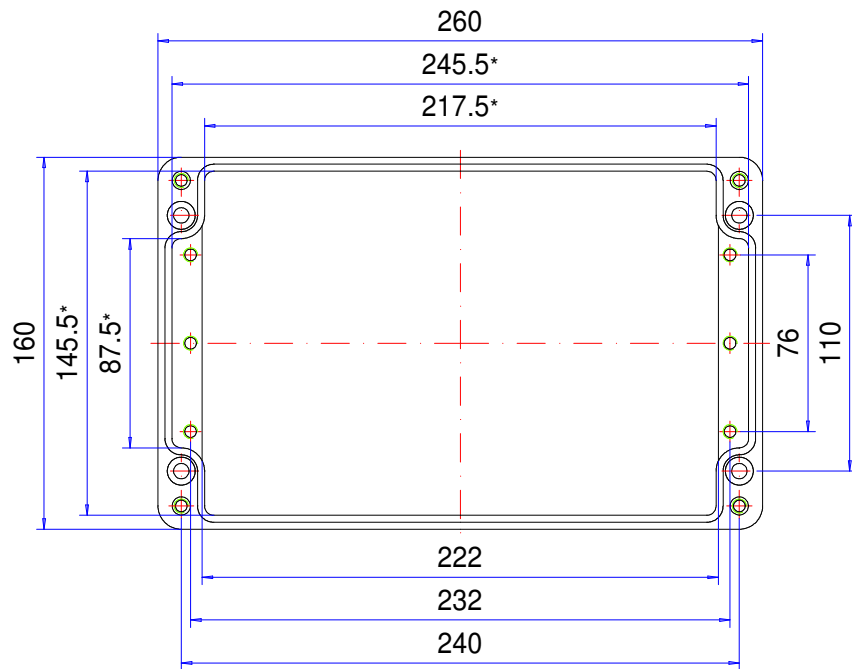

* Please note: Mould slope for casting ejection, dimensions in the amount of the bottom!

Enclosure material	Polyester GrP, UL 94 V-0, RAL 7000, squirrel grey		Ingress protection	IP65 EN 60529
Lid screws	4x stainless steel 1.4567 (V2A), captive		Weight	1.710 g
Gasket	1x Chloroprene (CR), light grey		Tolerance	DIN ISO 16901 T-130 (outside dimensions ±0,5mm)

180.162.000
polyKOM PK 162



Product overview

Material	Polyester
Protection Class	IP 65 EN 60529
Color	RAL 7000
Certifications	Germanischer Lloyd (optional), GOST
Length (L)	260 mm
Width (W)	160 mm
Height (H)	90 mm
Weight (g)	1710 g

polyKOM

THE POLYESTER STANDARD ENCLOSURE

IP 65

The key product features:

- Enclosure material: glass-fibre reinforced polyester
- Enclosure surface: similar to RAL 7000
- Compatible with standard enclosures available on the market, therefore easy to exchange
- Flammability: UL-94 V0
- Lid screws stainless steel 1.4567
- Enclosure seal: O-ring gasket (EPDM)

polyKOM is a practical and economic range of standard IP 65 enclosures made from weather-resistant polyester. The enclosures are available in 15 industry standard sizes which makes them interchangeable with other standard products. All types of electronic components and electrical assemblies can be fitted inside.

Options include external hinges, exterior supporting hinges and external mounting brackets. Threaded screw bosses are provided in the base for fitting mounting plates, circuit boards or terminal rails. Cable glands and other accessories are also available.

We can supply polyKOM enclosures fully customised to your requirements.

Enclosure sizes

15

Further information

Corrosion-resistant

Locking screws with plus/minus screw head or captive Allen screw

Application-specific accessories available

Full protective insulation in accordance with VDE 0100

Enclosure

Polyester glass fibre reinforced, halogen-free

similar to RAL 7000, squirrel grey, surface resistance > 10⁹ Ohm

Optional: similar to RAL 9005, deep black, surface resistance < 10⁹ Ohm

1° mould slope for casting ejection > internal circumference dimensions decrease by 1° towards enclosure bottom.

Flammability

UL 94 V-0, self-extinguishing

Fastening

Separate screw channels outside of the enclosure interior

Optional: External mounting brackets made from stainless steel

Internal mounting

M4/M6 threaded bushing on the enclosure base

Ingress protection

IP 65 / EN 60529, VDE 0470-1

Gasket

O-ring gasket (EPDM)

Optional: Silicone gasket

Lid screws

Stainless steel 1.4567, captive

Customising

Learn more about our [full customising service for installation-ready enclosures](#)

Full-Service-Products

Customization according to your wishes.



Our passion is enclosures.



Expert advice

Everything begins with individual advice. We'll be pleased to support you with your project and find solutions for every requirement. Customer-specific solutions are our speciality.



Sample service

Test our products with your internal mounting. We'll be pleased to send you a sample enclosure for inspection with no strings attached.



Drilling

We'll manufacture every enclosure for you according to your exact specifications – whether they involve precise drilling or large tolerance.



Milling

Thanks to our modern CNC production, we can quickly and efficiently mill custom-fit cut-outs and contours to match your exact specifications.



Engraving

Our services also include engraving your logo and other elements, which we can of course perform in any colour you desire.



Lasering

We can process stainless steel enclosures and plates quickly and reliably according to your individual requirements thanks to our in-house lasering centre.



Powder coating

We can powder coat enclosures, command enclosures and suspension systems in any RAL colour you desire. Custom colours are of course also possible.



Painting

We can also paint all our enclosures in any RAL colour you desire. The application of primer and special colour structures are possible, as well.



Serigraphy

If desired, we can apply your logo and lettering or other markings using serigraph printing.



Digital printing

Digital printing is particularly worthwhile for low-volume orders and for realising complex patterns or images.



EMC enclosures

We offer our conFORM low-price standard EMC enclosure to protect your internal mounting against electromagnetic radiation. On request, we can also supply an EMC-compliant version of any other ROLEC enclosure.



Displays

We are able to offer the right made-to-measure display for all our enclosures – in varying sizes and degrees of robustness depending on the application.



Accessories

ROLEC's portfolio also includes matching front plates, mounting plate, supporting rails and terminal blocks as well as a range of cable glands, blanking plugs etc.



Assembly

Would you like to have all your components supplied already assembled? No problem. Our assembly team will be pleased to perform all assembly work on your behalf.



Our Service

If you have any requirements for services not listed here, please ask us. Customer-specific solutions are our speciality. We also are keen to take on unusual tasks.

We will help you with those challenges that many others would give up on.