

Enclosure series commandCASE

Type: CC 202

Material-No.: 193.202.000

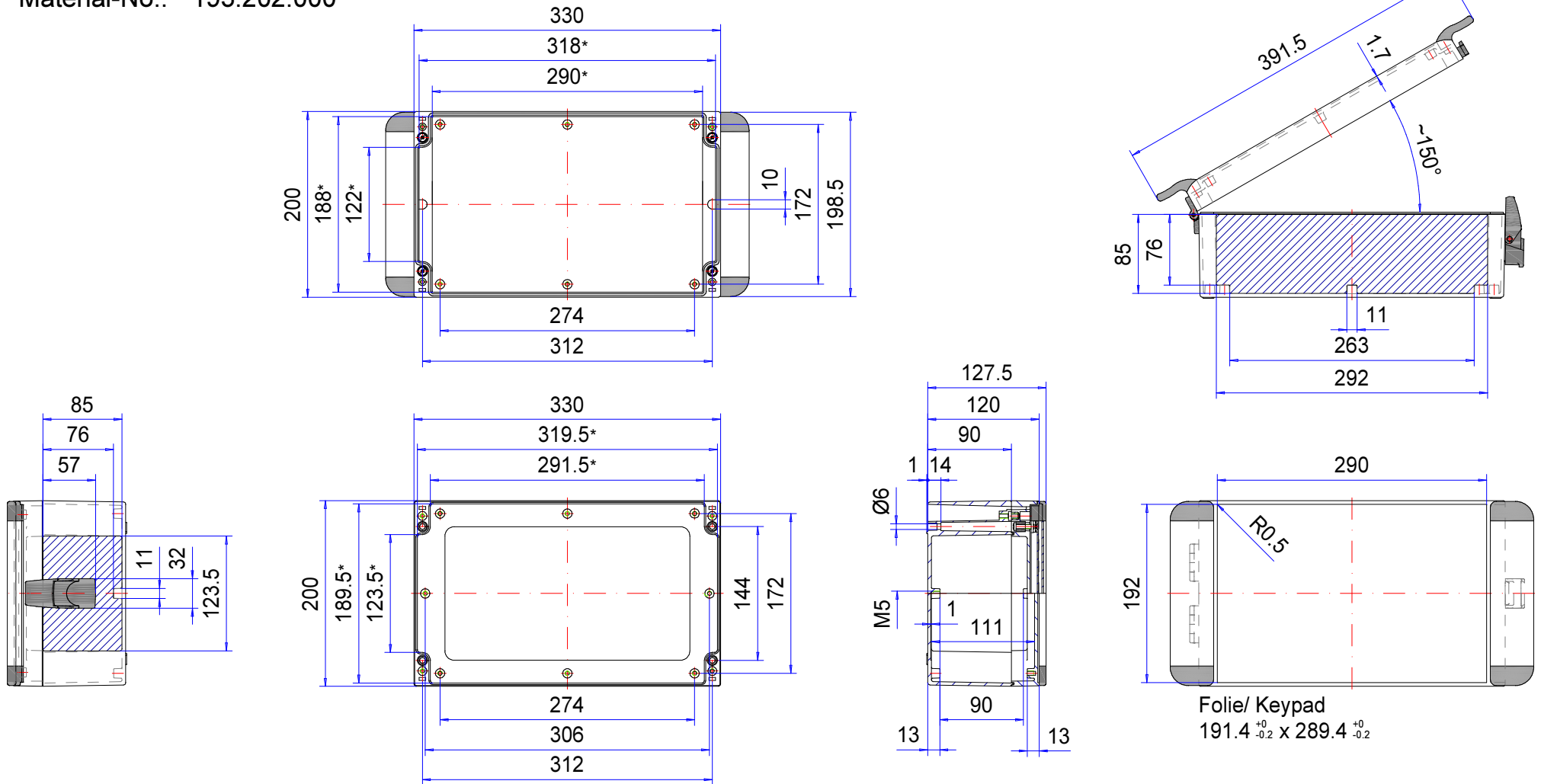

* Please note: Mould slope for casting ejection, dimensions in the amount of the bottom!

Enclosure material	GD-Al Si 12 (DIN 1725)		Ingress protection	IP66 EN 60529
Closure	2x hinge + 1x snap closure		Weight	3.228 g
Design grip "wings"	2x Aluminium anodized, 4x edge (POM), anthrazite grey		Coating	Powder coating RAL 7035, light grey
Assembly screws	5x M5x8, galvanized steel		Tolerance	GTA 13/5 DIN 1688-4 (outside dimensions ±0,5mm)
Gasket	1x Chloroprene (CR), light grey			

193.202.000
commandCASE CC 202



Product overview

Material	Aluminium
Protection Class	IP 66/EN 60529
Color	RAL 7035
Certifications	UL (optional), GOST
Length (L)	330 mm
Width (W)	200 mm
Height (H)	120 mm
Weight (g)	3038 g

commandCASE

THE MODERN OPERATING AND CONTROL ENCLOSURE

IP 66

The key product features:

- Enclosure material: diecast aluminium
- Enclosure surface: powder coating, RAL 7035
- Ergonomically shaped design handle bars
- Practical quick-acting closure
- Version CC: hinged lid with quick-action closure
- Version CCS: hinged lid, screw-fixed from the rear section
- Version CCV: fixed lid, screw-fixed from the rear section
- Connection to the suspension systems profiPLUS or tarSMART
- Integrated recess in cover for membrane keypad or front plate
- Enclosure seal: PUR

commandCASE is an elegant and economic range of diecast command and control enclosures. The highly attractive design perfectly matches our [profiPLUS suspension arm system](#), or [other modern arms systems](#). All models feature ergonomic handles on the front for easy positioning when suspended.

The range is available in three versions: with hinges and quick-action closure (also lockable), with hinges and screw fixing or as a fully screw fixed version. Lid supports provide strain-relief. The front is recessed to accommodate a membrane keypad, front plate or display panel. At the rear the screw channels are fitted with cover caps which also serve as edge protection. Threaded screw bosses are provided inside for mounting assemblies and components. Mounting plates, matching cable glands and other accessories are also available.

We can supply commandCASE enclosures fully customised to your requirements.

Enclosure sizes

6 sizes in 3 variants

Additional info

Designer handles

Integrated recess in the lid for membrane keypad or front plates

End caps made from polyoxymethylene (POM), RAL 7016 anthracite grey

Integrated lid support, PP (polypropylene), RAL 7040 window grey

Optional: Quick-acting closure and hinge, narrow side (side W)

Enclosure

Die-cast aluminium alloy

EN AN-44300 DIN EN 1706

(GD Al Si 12/DIN 1725)

1° mould slope for casting ejection > internal circumference dimensions decrease by 1° towards enclosure bottom.

Fastening

On a **ROLEC suspension arm system** or directly attached to the wall in the version with lock and hinge - with or without designer handles

Internal mounting

M5 fastening thread on the enclosure base and in the lid

Ingress protection

IP 66 / EN 60529

Gasket

PUR

Surface

Powder coating RAL 7035, light grey

Optional: Special colours

Optional: Corrosion protection

Customising

Learn more about our **full customising service for installation-ready enclosures**

Full-Service-Products

Customization according to your wishes.



Our passion is enclosures.



Expert advice

Everything begins with individual advice. We'll be pleased to support you with your project and find solutions for every requirement. Customer-specific solutions are our speciality.



Sample service

Test our products with your internal mounting. We'll be pleased to send you a sample enclosure for inspection with no strings attached.



Drilling

We'll manufacture every enclosure for you according to your exact specifications – whether they involve precise drilling or large tolerance.



Milling

Thanks to our modern CNC production, we can quickly and efficiently mill custom-fit cut-outs and contours to match your exact specifications.



Engraving

Our services also include engraving your logo and other elements, which we can of course perform in any colour you desire.



Lasering

We can process stainless steel enclosures and plates quickly and reliably according to your individual requirements thanks to our in-house lasering centre.



Powder coating

We can powder coat enclosures, command enclosures and suspension systems in any RAL colour you desire. Custom colours are of course also possible.



Painting

We can also paint all our enclosures in any RAL colour you desire. The application of primer and special colour structures are possible, as well.



Serigraphy

If desired, we can apply your logo and lettering or other markings using serigraph printing.



Digital printing

Digital printing is particularly worthwhile for low-volume orders and for realising complex patterns or images.



EMC enclosures

We offer our conFORM low-price standard EMC enclosure to protect your internal mounting against electromagnetic radiation. On request, we can also supply an EMC-compliant version of any other ROLEC enclosure.



Displays

We are able to offer the right made-to-measure display for all our enclosures – in varying sizes and degrees of robustness depending on the application.



Accessories

ROLEC's portfolio also includes matching front plates, mounting plate, supporting rails and terminal blocks as well as a range of cable glands, blanking plugs etc.



Assembly

Would you like to have all your components supplied already assembled? No problem. Our assembly team will be pleased to perform all assembly work on your behalf.



Our Service

If you have any requirements for services not listed here, please ask us. Customer-specific solutions are our speciality. We also are keen to take on unusual tasks.

We will help you with those challenges that many others would give up on.