

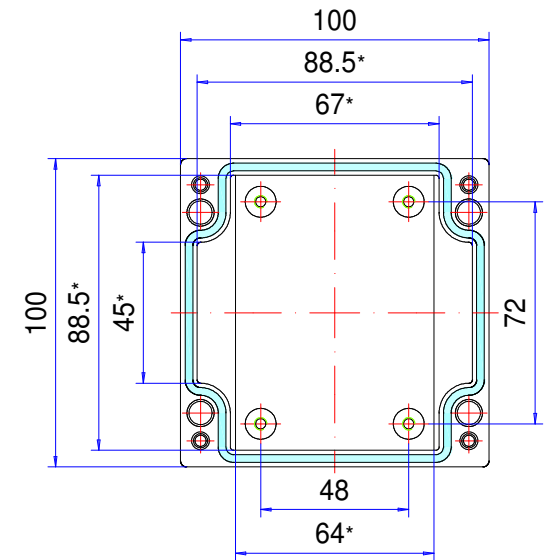

Enclosure series aluPLUS

Type: AP 100

Material-No.: 196.100.000

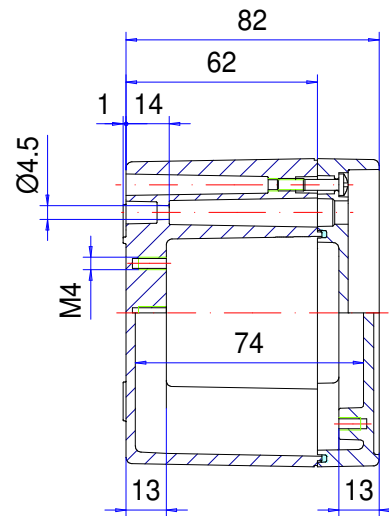
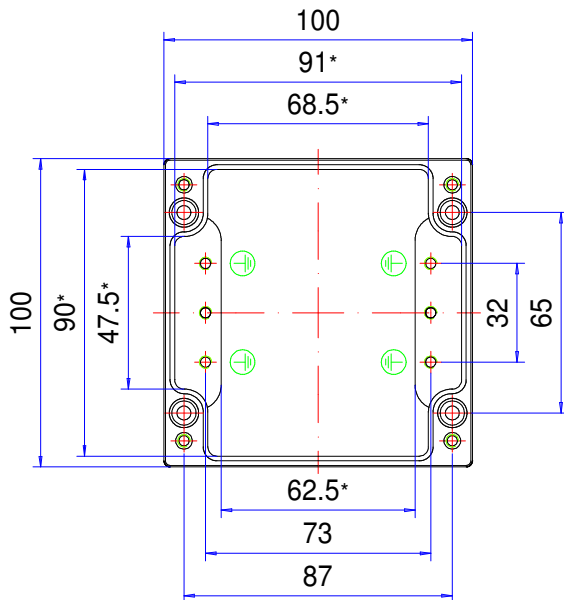
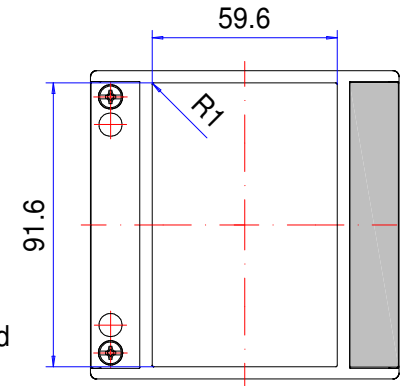
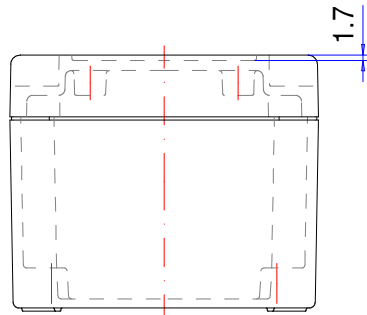

* Please note: Mould slope for casting ejection, dimensions in the amount of the bottom!

Enclosure material	GD-Al Si 12 (DIN 1725)		Ingress protection	IP66 EN 60529
Lid screws	4x stainless steel 1.4567 (V2A), captive		Weight	575 g
Assembly screws	5x M4x8, galvanized steel		Coating	Powder coating RAL 7035, light grey
Design covers	2x Polybutylene Ter. (PBT), RAL 7016, anthracite grey		Tolerance	GTA 13/5 DIN 1688-4 (outside dimensions ±0,5mm)
Gasket	1x moulded gasket, silicone, transparent			

196.100.000
aluPLUS AP 100



Product overview

Material	Aluminium
Protection Class	IP 66/EN 60529, IP 67/EN 60529
Color	RAL 7035
Certifications	UL (optional), GOST
Length (L)	100 mm
Width (W)	100 mm
Height (H)	82 mm
Weight (g)	575 g

aluPLUS

THE PLUS SIDE OF TECHNOLOGY AND DESIGN

IP 66, Optional: IP 67

The key product features:

- Enclosure material: diecast aluminium
- Enclosure surface: powder coating, RAL 7035
- Clip-on designcovers. RAL 7016
- The enclosure can be mounted even when the lid is fitted
- Integrated recess to accommodate a membrane keypad or front plate
- Compatible with standard enclosures available on the market, therefore easy to exchange
- Lid screws in stainless steel 1.4567
- Enclosure seal: Silicone moulded gasket

aluPLUS is a versatile and highly attractive range of diecast aluminium enclosures designed for modern industrial electronics. The range is available in eight industry standard sizes and rated to IP 66 and IP 67. The enclosures can be mounted on a wall or machine, or used as portable instruments.

Design features include a recessed lid, for fitting a membrane keypad or product label, clip-on plastic design covers which hide the lid fixing and mounting screws, and lid retaining straps which keep the lid in place when open. The enclosures can be mounted without opening the lid which means your electronics remain protected at all times. Threaded screw bosses are provided in the base and lid for fitting PCBs, mounting plates, terminal rails etc. An extensive range of accessories and matching cable glands is also available.

We can supply aluPLUS enclosures fully customised to your requirements.

Enclosure sizes

8

Additional info

Fastening with closed enclosures

Integrated recess in the lid for membrane keypad or front plates

Optional: Lid supports with integrated stainless steel (V2A) lid screw and plastic (PA6) lid retaining strap.

Clip-on design covers, plastic PBT (polybutylene terephthalate), similar to RAL 7016 anthracite grey

Enclosure

Diecast aluminium alloy

EN AN-44300 DIN EN 1706

(GD Al Si 12/DIN 1725)

1° mould slope for casting ejection > internal circumference dimensions decrease by 1° towards enclosure bottom.

Fastening

Separate screw channels

Internal mounting

M5 fastening thread on the enclosure base and in the lid

Ingress protection

IP 66 / EN 60529

Optional: IP 67 / EN 60529

Gasket

Silicone moulded gasket

Optional: Chloroprene O-ring gasket (CR)

Lid screws

Stainless steel 1.4567, captive

Surface

Powder coating RAL 7035, light grey

Optional: Special colours

Optional: Corrosion protection

Customising

Learn more about our [full customising service for installation-ready enclosures](#)

Full-Service-Products

Customization according to your wishes.



Our passion is enclosures.



Expert advice

Everything begins with individual advice. We'll be pleased to support you with your project and find solutions for every requirement. Customer-specific solutions are our speciality.



Sample service

Test our products with your internal mounting. We'll be pleased to send you a sample enclosure for inspection with no strings attached.



Drilling

We'll manufacture every enclosure for you according to your exact specifications – whether they involve precise drilling or large tolerance.



Milling

Thanks to our modern CNC production, we can quickly and efficiently mill custom-fit cut-outs and contours to match your exact specifications.



Engraving

Our services also include engraving your logo and other elements, which we can of course perform in any colour you desire.



Lasering

We can process stainless steel enclosures and plates quickly and reliably according to your individual requirements thanks to our in-house lasering centre.



Powder coating

We can powder coat enclosures, command enclosures and suspension systems in any RAL colour you desire. Custom colours are of course also possible.



Painting

We can also paint all our enclosures in any RAL colour you desire. The application of primer and special colour structures are possible, as well.



Serigraphy

If desired, we can apply your logo and lettering or other markings using serigraph printing.



Digital printing

Digital printing is particularly worthwhile for low-volume orders and for realising complex patterns or images.



EMC enclosures

We offer our conFORM low-price standard EMC enclosure to protect your internal mounting against electromagnetic radiation. On request, we can also supply an EMC-compliant version of any other ROLEC enclosure.



Displays

We are able to offer the right made-to-measure display for all our enclosures – in varying sizes and degrees of robustness depending on the application.



Accessories

ROLEC's portfolio also includes matching front plates, mounting plate, supporting rails and terminal blocks as well as a range of cable glands, blanking plugs etc.



Assembly

Would you like to have all your components supplied already assembled? No problem. Our assembly team will be pleased to perform all assembly work on your behalf.



Our Service

If you have any requirements for services not listed here, please ask us. Customer-specific solutions are our speciality. We also are keen to take on unusual tasks.

We will help you with those challenges that many others would give up on.