

Enclosure series starCASE

Type: SC 150

Material-No.: 230.150.000

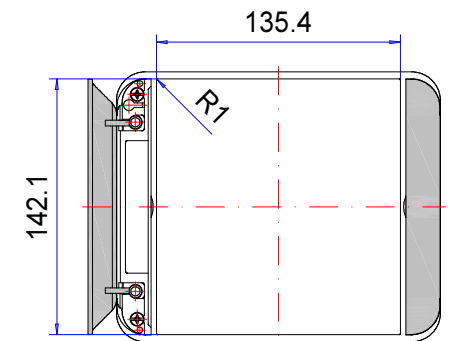
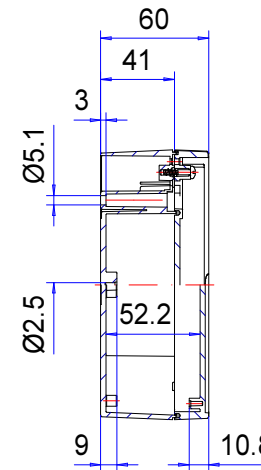
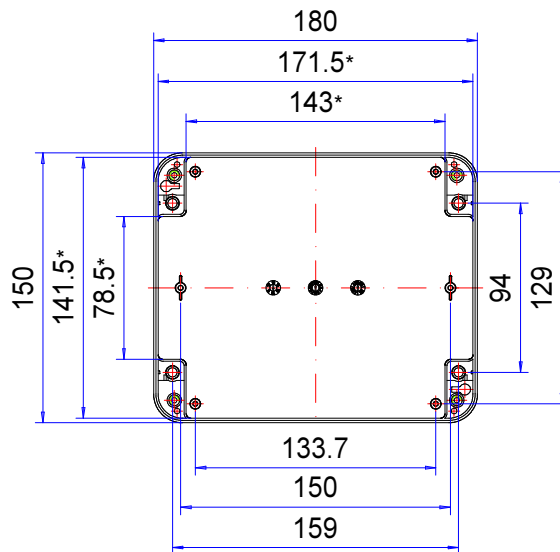
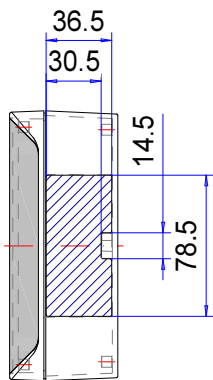
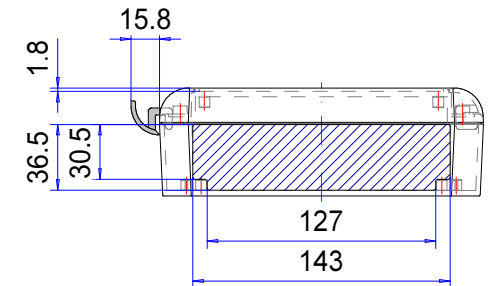
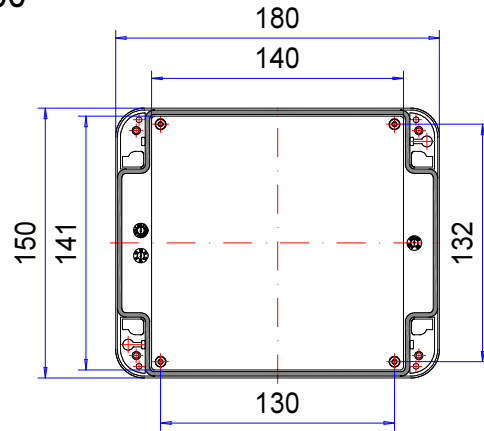

Folie /Keypad
141.9⁺⁰_{-0.2} x 135.2⁺⁰_{-0.2}

* Please note: Mould slope for casting ejection, dimensions in the amount of the bottom!

Enclosure material	ASA/PC, UL94 V0-1,5mm, RAL 7035, light grey		Weight	350 g
Lid screws	4x stainless steel 1.4567 (V2A), captive		Assembly screws	4x KBLØ3x8,5, galvanized steel
Gasket	1x moulded gasket, silicone, black		Lid supports	2x Polypropylen (PP), white
Ingress protection	IP66 EN 60529		Tolerance	DIN ISO 16901-130 (outside dimensions ±0,5mm)

230.150.000
starCASE SC 150



Product overview

Material	ASA LURAN
Protection Class	IP 66/EN 60529
Color	RAL 7035
Certifications	GOST
Length (L)	180 mm
Width (W)	150 mm
Height (H)	60 mm
Weight (g)	350 g

starCASE

THE THERMOPLASTIC DESIGN ENCLOSURE FOR ELECTRONICS & DEVICES

IP 66

The key product features:

- Enclosure material: ASA + PC
- Enclosure colour similar to RAL 7035
- Integrated lid support
- The enclosure can be mounted when the lid is fitted
- Lid screws stainless steel 1.4567
- Integrated recess in cover for membrane keypad or front plate
- Design covers to conceal the assembly level
- Fire protection class UL-94 V-0
- Enclosure seal: silicone moulded seal

starCASE is a truly multipurpose range of plastic enclosures moulded in flame-retardant ASA+PC. These highly attractive and ergonomic housings are perfectly suitable for modern industrial electronics. The enclosures can be mounted on a wall, bulkhead, ceiling or machine – everything is possible.

Unique ROLEC design features include a recessed lid for fitting a membrane keypad, product label or front plate, hinged design covers which hide the lid screws and separate mounting channels, and lid retaining supports for holding the lid in place when the housing is open. The enclosures can be mounted without opening the lid which means your electronics remain protected at all times. Screw bosses are provided inside for fitting circuit boards, mounting plates, terminal rails etc. Matching accessories and cable glands are also available.

We can supply starCASE enclosures fully customised to your requirements.

Enclosure sizes

8

Further information

Integrated recess for membrane keypads or front plates

Integrated lid support, polypropylene (PP)

Optional: Access safeguard by means of sealing set

Full protective insulation in accordance with VDE 0100

Enclosure

ASA+PC, RAL 7035 light grey: 2° mould slope for casting ejection > internal circumference dimensions decrease by 2° towards enclosure base.

Snap-on design covers, captive, ASA LURAN S, RAL 7035 light grey

Special materials and colours on request

Flammability

UL 94 V-0 1.5 mm

Fastening

Separate screw channels outside of the enclosure interior. Enclosure fastened while lid closed

Internal mounting

Fastening option for self-grooving screws on the base of the enclosure and in the lid

Ingress protection

IP 66 / EN 60529

Gasket

Silicone moulded seal

Lid screws

Stainless steel 1.4567, captive

Customising

Learn more about our [full customising service for installation-ready enclosures](#)

Full-Service-Products

Customization according to your wishes.



Our passion is enclosures.



Expert advice

Everything begins with individual advice. We'll be pleased to support you with your project and find solutions for every requirement. Customer-specific solutions are our speciality.



Sample service

Test our products with your internal mounting. We'll be pleased to send you a sample enclosure for inspection with no strings attached.



Drilling

We'll manufacture every enclosure for you according to your exact specifications – whether they involve precise drilling or large tolerance.



Milling

Thanks to our modern CNC production, we can quickly and efficiently mill custom-fit cut-outs and contours to match your exact specifications.



Engraving

Our services also include engraving your logo and other elements, which we can of course perform in any colour you desire.



Lasering

We can process stainless steel enclosures and plates quickly and reliably according to your individual requirements thanks to our in-house lasering centre.



Powder coating

We can powder coat enclosures, command enclosures and suspension systems in any RAL colour you desire. Custom colours are of course also possible.



Painting

We can also paint all our enclosures in any RAL colour you desire. The application of primer and special colour structures are possible, as well.



Serigraphy

If desired, we can apply your logo and lettering or other markings using serigraph printing.



Digital printing

Digital printing is particularly worthwhile for low-volume orders and for realising complex patterns or images.



EMC enclosures

We offer our conFORM low-price standard EMC enclosure to protect your internal mounting against electromagnetic radiation. On request, we can also supply an EMC-compliant version of any other ROLEC enclosure.



Displays

We are able to offer the right made-to-measure display for all our enclosures – in varying sizes and degrees of robustness depending on the application.



Accessories

ROLEC's portfolio also includes matching front plates, mounting plate, supporting rails and terminal blocks as well as a range of cable glands, blanking plugs etc.



Assembly

Would you like to have all your components supplied already assembled? No problem. Our assembly team will be pleased to perform all assembly work on your behalf.



Our Service

If you have any requirements for services not listed here, please ask us. Customer-specific solutions are our speciality. We also are keen to take on unusual tasks.

We will help you with those challenges that many others would give up on.