

Enclosure series aluCLIC

Type: ACL 092

Material-No.: 240.092.000

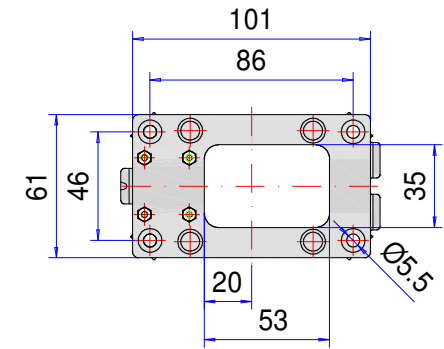
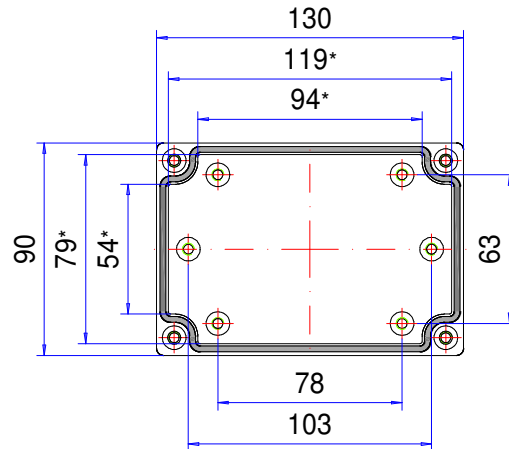

Snap-on device

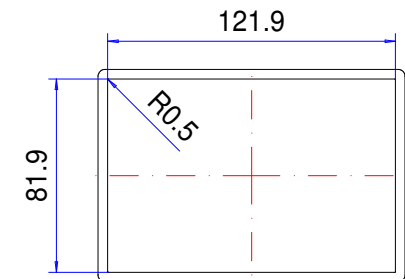
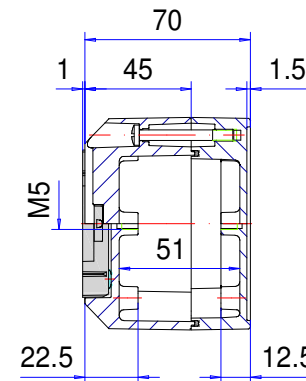
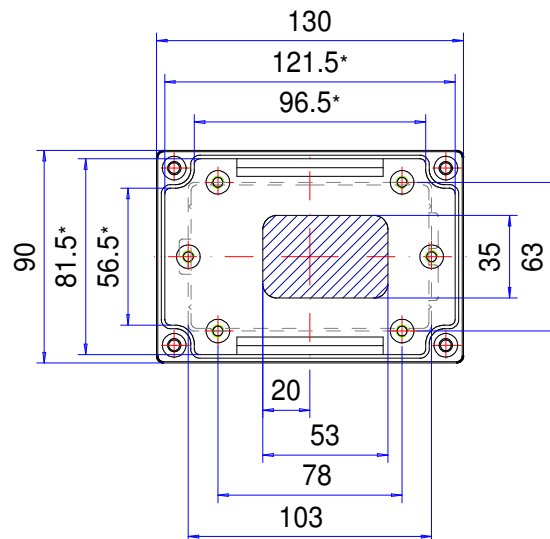

Folie/ Keypad
81.3⁺⁰_{-0.2} x 121.3⁺⁰_{-0.2}

* Please note: Mould slope for casting ejection, dimensions in the amount of the bottom!

Enclosure material	GD-Al Si 12 (DIN 1725)		Vibration	DIN EN 60068-2-6, inspection Fc, acceleration 4gn
Lid screws	4x stainless steel 1.4567 (V2A), captive		Weight	610 g
Gasket	1x TPE moulded gasket, silicone-free, black		Assembly screws	5x M5x8, galvanized steel
Snap-on device	1x Polyoxymethylen (POM), RAL 9005, deep black		Coating	Powder coating RAL 7035, light grey
Ingress protection	IP67 EN 60529		Tolerance	GTA 13/5 DIN 1688-4 (outside dimensions ±0,5mm)

240.092.000
aluCLIC ACL 092



Product overview

Material	Aluminium
Protection Class	IP 66/EN 60529, IP 67/EN 60529, IP 69K
Color	RAL 7035
Certifications	GOST
Length (L)	130 mm
Width (W)	90 mm
Height (H)	70 mm
Weight (g)	610 g

aluCLIC

THE QUICK-CHANGE ENCLOSURES

IP 66, IP 67 - Optional: IP 69K

The key product features:

- Enclosure material: diecast aluminium
- Enclosure surface: powder coating, RAL 7035
- Lid fixed from the rear
- Enclosure can be mounted even when the lid is fitted
- Integrated recess in cover for membrane keypad or front plate
- Snap-on fastening to quick-change support
- Enclosure front almost fully usable
- Lid screws in stainless steel 1.4567
- Enclosure seal: TPE moulded gasket, silicone-free

aluCLIC is a very attractive and unique range of aluminium enclosures which is designed for quick installation and rapid exchange of electronics equipment. A snap lock located under the enclosure can be easily disengaged and the enclosure changed in an instant. These enclosures really are practical, fast and neat to install.

Standard features include a full sized recessed area in the lid to accommodate a membrane keypad, front plate or product label, hidden assembly screws on the underside and threaded screw bosses in the base and lid for PCBs, mounting plates, DIN rails etc.. The enclosure snap-on device can be easily fastened to a wall, ceiling or a machine housing.

We can supply aluCLIC enclosures fully customised to your requirements

Enclosure sizes

3

Additional info

Snap-on instead of mounted by screws

Change the enclosure in seconds

More space for the electronics

Enclosure front fully usable

Lid screwed on rear side

Integrated recess in the lid for a membrane keypad, front plate or product label

Enclosure

Diecast aluminium alloy

EN AN-44300 DIN EN 1706

(GD Al Si 12/DIN 1725)

1° mould slope for casting ejection > internal circumference dimensions decrease by 1° towards enclosure bottom.

Fastening

Snap-on device, plastic (POM), RAL 9005 deep black

Internal mounting

M5 fastening thread on the enclosure base and in the lid

Ingress protection

IP 66, IP 67 / EN 60529

Optional: IP 69K / DIN 40050

Gasket

TPE moulded gasket, silicone-free

Optional: Silicone gasket

Lid screws

Stainless steel 1.4567, captive

Surface

Powder coating RAL 7035, light grey

Optional: Special colours

Optional: Corrosion protection

Customising

Learn more about our [full customising service for installation-ready enclosures](#)

Full-Service-Products

Customization according to your wishes.



Our passion is enclosures.



Expert advice

Everything begins with individual advice. We'll be pleased to support you with your project and find solutions for every requirement. Customer-specific solutions are our speciality.



Sample service

Test our products with your internal mounting. We'll be pleased to send you a sample enclosure for inspection with no strings attached.



Drilling

We'll manufacture every enclosure for you according to your exact specifications – whether they involve precise drilling or large tolerance.



Milling

Thanks to our modern CNC production, we can quickly and efficiently mill custom-fit cut-outs and contours to match your exact specifications.



Engraving

Our services also include engraving your logo and other elements, which we can of course perform in any colour you desire.



Lasering

We can process stainless steel enclosures and plates quickly and reliably according to your individual requirements thanks to our in-house lasering centre.



Powder coating

We can powder coat enclosures, command enclosures and suspension systems in any RAL colour you desire. Custom colours are of course also possible.



Painting

We can also paint all our enclosures in any RAL colour you desire. The application of primer and special colour structures are possible, as well.



Serigraphy

If desired, we can apply your logo and lettering or other markings using serigraph printing.



Digital printing

Digital printing is particularly worthwhile for low-volume orders and for realising complex patterns or images.



EMC enclosures

We offer our conFORM low-price standard EMC enclosure to protect your internal mounting against electromagnetic radiation. On request, we can also supply an EMC-compliant version of any other ROLEC enclosure.



Displays

We are able to offer the right made-to-measure display for all our enclosures – in varying sizes and degrees of robustness depending on the application.



Accessories

ROLEC's portfolio also includes matching front plates, mounting plate, supporting rails and terminal blocks as well as a range of cable glands, blanking plugs etc.



Assembly

Would you like to have all your components supplied already assembled? No problem. Our assembly team will be pleased to perform all assembly work on your behalf.



Our Service

If you have any requirements for services not listed here, please ask us. Customer-specific solutions are our speciality. We also are keen to take on unusual tasks.

We will help you with those challenges that many others would give up on.