

Enclosure series aluNORM

Type: AS 060

Material-No.: 100.060.035

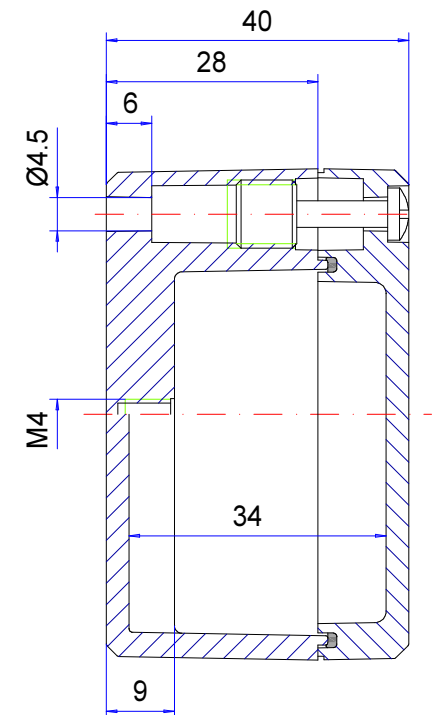
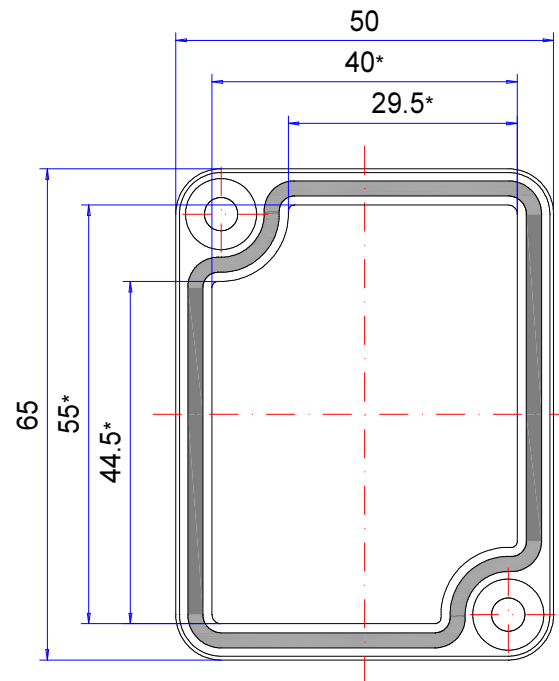
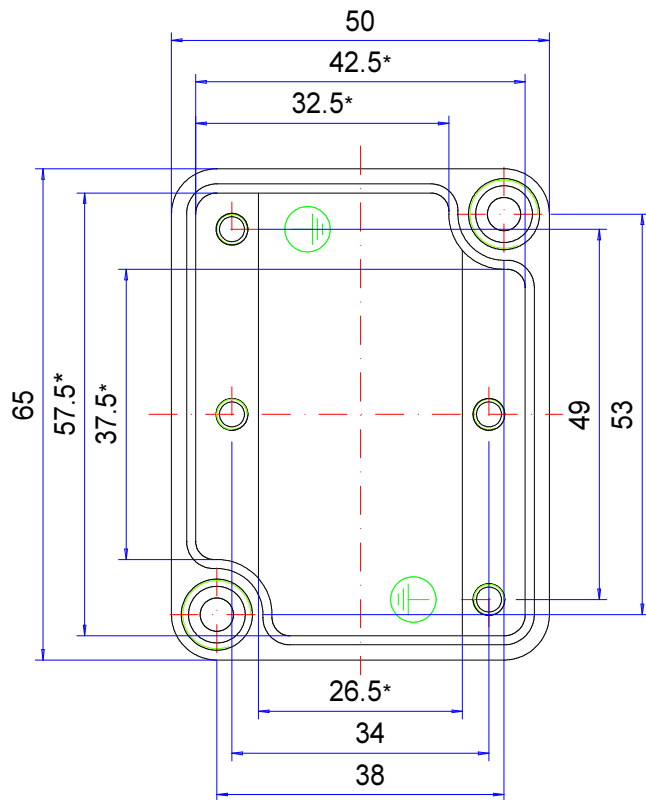

* Please note: Mould slope for casting ejection, dimensions in the amount of the bottom!

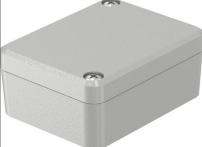
Enclosure material	GD-AI Si 12 (DIN 1725)		Weight	130 g
Lid screws	2x stainless steel 1.4567 (V2A), captive		Earthing screws	2x M4x6, copper-plated
Gasket	1x TPE moulded gasket, silicone-free, black		Coating	Powder coating RAL 7035, light grey
Ingress protection	IP66 EN 60529		Tolerance	DIN CEN ISO/TS 8062-2 (outside dimensions ± 0,5mm)

100.060.035
aluNORM AS 060



Product overview

Material	Aluminium
Protection Class	IP 66/EN 60529, IP 67/EN 60529
Color	RAL 7035
Certifications	CSA (optional), UL (optional), GOST
Length (L)	50 mm
Width (W)	65 mm
Height (H)	40 mm
Weight (g)	130 g

aluNORM

THE MULTIVARIABLE ENCLOSURE

IP 66, Optional: IP 67

The key product features:

- Enclosure material: diecast aluminium
- Enclosure surface: powder coating, RAL 7035
- Single-channel mounting for greater installation volume
- Sizes compatible with polyTOP polyester enclosures, therefore easy to exchange
- Lid screws in stainless steel 1.4567
- Enclosure seal: TPE moulded or PUR gasket, silicone-free

aluNORM IP 66 diecast aluminium enclosures are designed to protect electrical and electronic components. The enclosures are available in four different versions with different lid and base combinations. This gives a huge variety of sizes and design options to choose from.

Uniquely, aluNORM enclosures are mounted to a wall or machine using the same screw channels as the lid fixings. This means there is more space inside for your assemblies and components. EMC shielded versions are available for the AS and AD variants, and some AF and AH variants - see ordering details. Threaded screw bosses in the lid and base enable fast installation of terminal rails, mounting plates etc. Matching cable glands and accessories are also available.

We can supply aluNORM enclosures fully customised to your requirements.

Enclosure sizes

86

Additional info

4 different variants

AS (deep bottom, flat lid)

AD (flat bottom, deep lid)

AF (flat bottom, flat lid)

AH (deep bottom, deep lid)

Compatible assembly dimensions with the polyTOP range (polyester enclosure)

Optional: Specially developed external mounting brackets made from die-cast aluminium, available from AS 080

Enclosure

Diecast aluminium

EN AC 44300/EN AC-44200 (DIN EN 1706)

1° mould slope for casting ejection > internal circumference dimensions decrease by 1° towards enclosure bottom.

Fastening

Space-saving single-channel technology for lid and fastening screws outside of the enclosure interior
Even square enclosures can be screwed into any position without problems, thanks to the symmetrical arrangement

Internal mounting

Fastening thread in lateral bars on the floor of the enclosure and a fastening option and/or thread in the lid
(both depending on the variant)
Mounting plate made from galvanised sheet steel available as an accessory

Ingress protection

IP 66 / EN 60529
Optional: IP 67 / EN 60529

Gasket

TPE moulded or PUR gasket, silicone-free

Lid screws

Stainless steel 1.4567, captive

Surface

Powder coating RAL 7035 light grey
Optional: Special colours
Optional: Corrosion protection

Customising

Learn more about our [full customising service for installation-ready enclosures](#)

Full-Service-Products

Customization according to your wishes.



Our passion is enclosures.



Expert advice

Everything begins with individual advice. We'll be pleased to support you with your project and find solutions for every requirement. Customer-specific solutions are our speciality.



Sample service

Test our products with your internal mounting. We'll be pleased to send you a sample enclosure for inspection with no strings attached.



Drilling

We'll manufacture every enclosure for you according to your exact specifications – whether they involve precise drilling or large tolerance.



Milling

Thanks to our modern CNC production, we can quickly and efficiently mill custom-fit cut-outs and contours to match your exact specifications.



Engraving

Our services also include engraving your logo and other elements, which we can of course perform in any colour you desire.



Lasering

We can process stainless steel enclosures and plates quickly and reliably according to your individual requirements thanks to our in-house lasering centre.



Powder coating

We can powder coat enclosures, command enclosures and suspension systems in any RAL colour you desire. Custom colours are of course also possible.



Painting

We can also paint all our enclosures in any RAL colour you desire. The application of primer and special colour structures are possible, as well.



Serigraphy

If desired, we can apply your logo and lettering or other markings using serigraph printing.



Digital printing

Digital printing is particularly worthwhile for low-volume orders and for realising complex patterns or images.



EMC enclosures

We offer our conFORM low-price standard EMC enclosure to protect your internal mounting against electromagnetic radiation. On request, we can also supply an EMC-compliant version of any other ROLEC enclosure.



Displays

We are able to offer the right made-to-measure display for all our enclosures – in varying sizes and degrees of robustness depending on the application.



Accessories

ROLEC's portfolio also includes matching front plates, mounting plate, supporting rails and terminal blocks as well as a range of cable glands, blanking plugs etc.



Assembly

Would you like to have all your components supplied already assembled? No problem. Our assembly team will be pleased to perform all assembly work on your behalf.



Our Service

If you have any requirements for services not listed here, please ask us. Customer-specific solutions are our speciality. We also are keen to take on unusual tasks.

We will help you with those challenges that many others would give up on.